

# USTC-IME LGAD design and performance

Xiangxuan Zheng, May 13<sup>th</sup>

On behalf of USTC HGTD Sensor Group

University of Science and Technology of China

# Overview

- Introduction
  - HGTD (High-Granularity Timing Detector)
  - USTC-IME 2.X LGAD
- Measured result of USTC-IME 2.X LGAD
  - Radiation hardness
  - On wafer/Large Array IV&CV
  - Collected charge and time resolution from beta-scope
  - Inter-pad gap distance by testbeam (fill factor)
  - Inter-pad resistance and capacitance (checked for cross-talk)
- Conclusion

# ATLAS HGTD project

- LHC (Large Hadron Collider) → HL-LHC (high-luminosity phase of LHC) in 2028 → pileup vertex densities ↑
- ATLAS (one of the 4 major experiments at the LHC at CERN) → upgrade its detectors
- The HGTD (High-Granularity Timing Detector) is chosen for the ATLAS Phase II upgrade.
- The time information be used as another dimension for identifying the hard-scattering vertex at the HL-LHC.
- HGTD should withstand the non ionizing radiation levels throughout the HL-LHC operations.
  - This determines sensors' lifetime
- Because of its good timing performance and radiation hardness, LGAD (Low Gain Avalanche Detector) has been chosen as the sensor.



ATLAS Detector in LHC

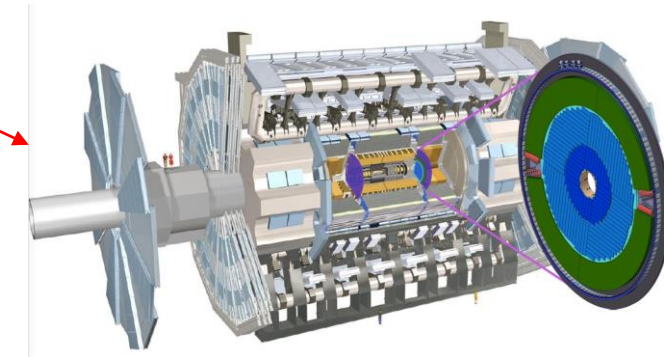

Position of the HGTD within ATLAS

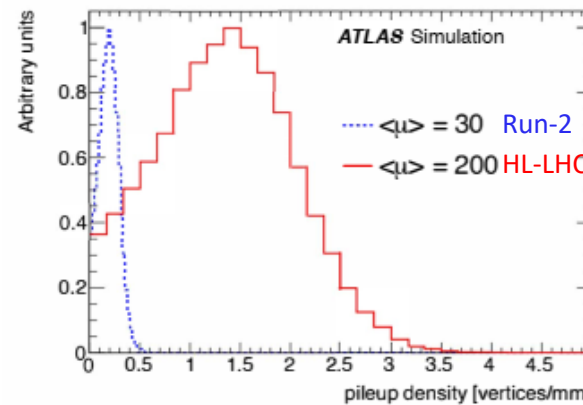

Local pileup vertex densities at generator level

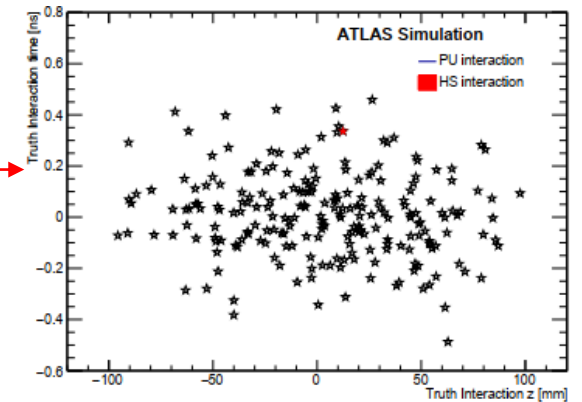

truth interactions in a single bunch crossing in the z-t plane

# Low Gain Avalanche Detector

- LGADs are n-in-p silicon detectors containing an extra highly-doped p-layer (gain layer) below the n-p junction.
- The high electric field in gain layer region will accelerate the drifting electrons and generate avalanches.
- With a proper design of gain layer, the LGAD can achieve promising S/N and time resolution.
- Designed parameters:
  - Active thickness: 50  $\mu\text{m}$
  - Pad size: 1.3 x 1.3  $\text{mm}^2$
  - Hit efficiency: > 95%
  - Radiation tolerance:  $2.5 \times 10^{15} \text{ n}_{\text{eq}} \text{ cm}^{-2}$ , 1.5 MGy

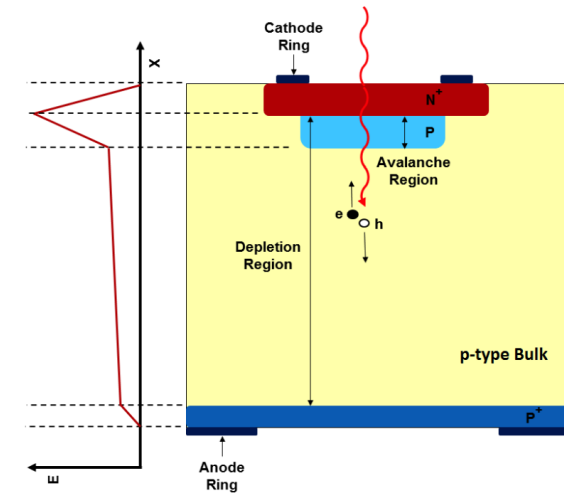

1 LGAD pad

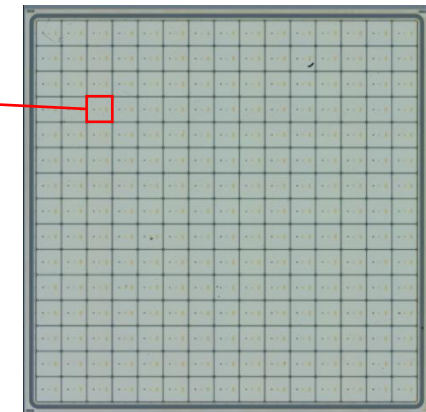

15x15 LGAD sensor

# USTC's roadmap on LGAD R&D with IME

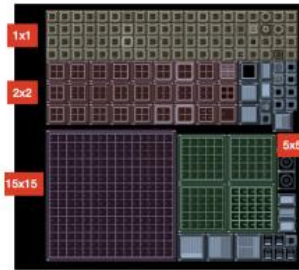

**USTC-1.0**

Deliver: 2020.7

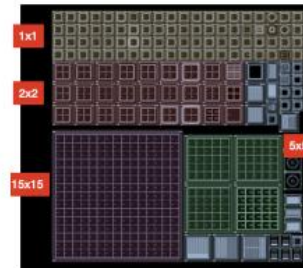

**USTC-1.1**

Deliver: 2020.10

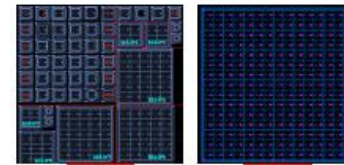

Small 15\*15

**USTC-2.0**

Deliver: 2021.4

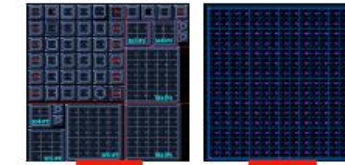

Small 15\*15

**USTC-2.1**

Deliver: 2021.10

	USTC-1.0	USTC-1.1	USTC-2.0	USTC-2.1
Propose	First attempt	Improved the process technology, same layout as 1.0	New layout, mainly for yield study and issues fix	Same layout as 2.0, fast iteration
Performance	Few sensors can work (VBD ~250V, VGL 40V)	~30% can work (VBD ~300V)	> 99% small sensors and ~35% 15x15 sensors can work, GR leakage disappeared. VBD lowered (~100-170V).	>99% small sensors and ~35% 15x15 sensors can work. Better uniformity, VBDs in idea range (~150-240V). Performance verified in $\beta$ /Laser/TB and individual institute (JSI)
Problem	Almost all sensors have large current (VBD < 10V)	Almost all sensors have large GR current	Too low VBD for some wafers.	

# Design requirement and challenge

Characteristics of LGAD	Requirement	Test method
Radiation hardness	<ol style="list-style-type: none"> <li>1. Use c-factor to present the radiation hardness</li> <li>2. Other parameters should meet the requirement at <math>2.5 \times 10^{15} \text{ n}_{\text{eq}} \text{ cm}^{-2}</math> irradiation fluence.</li> </ol>	Measure CV at different fluences to calculate c-factor to present the radiation hardness
Yield		On-wafer IV test
Uniformity	< 5% for V@2 $\mu$ A	Large-Array IV&CV test
Collected charge	> 4fC	beta-scope test
Time resolution	< 40ps (start), < 70 ps (end of lifetime)	
Fill factor	Inter-pad gap distance < 100 $\mu$ m	Test-beam
Quality of the pad isolation	Inter-pad resistance > 1 G $\Omega$	Inter-pad IV&CV test

# Radiation hardness of LGAD

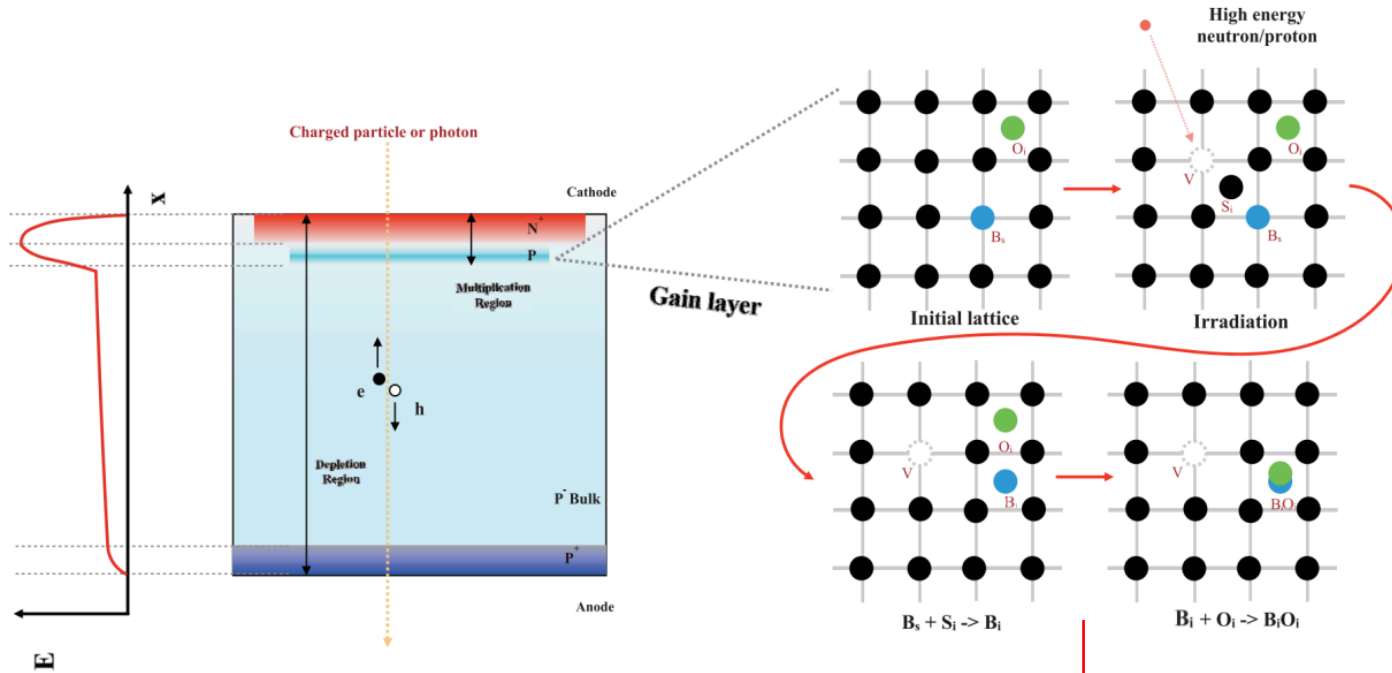

The LGAD Structure

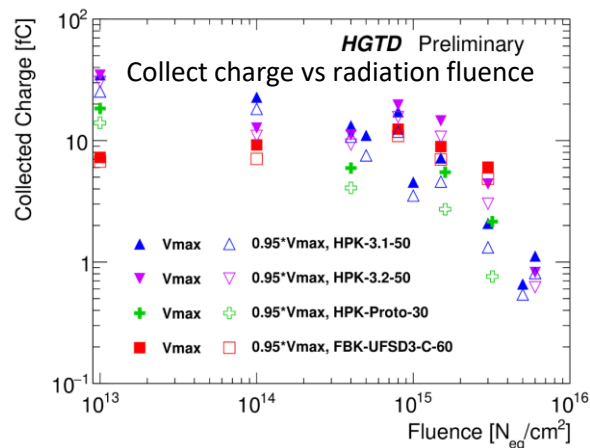

Carbon diffusion

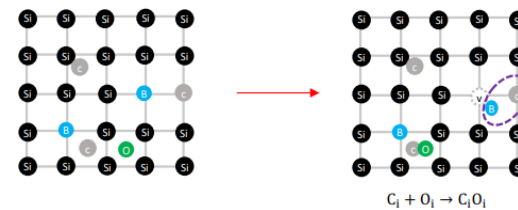

- The BiO<sub>i</sub> generated after irradiation will reduce the effective doping concentration and detector's gain.

V : Vacancy    Acceptor (B<sub>s</sub>) removal in the gain layer after irradiation  
 S<sub>i</sub>: interstitial silicon  
 B<sub>i</sub>: interstitial boron  
 O<sub>i</sub>: interstitial oxygen  
 B<sub>s</sub>: substitutional boron

$$\rho_A(\phi) = g_{eff}\phi + \rho_A(0)e^{-c\phi}$$

Described by the exponential model

- The c-factor is used to describe LGAD's radiation hardness (degradation rate of the gain layer).

- The C<sub>i</sub> + O<sub>i</sub> → C<sub>i</sub>O<sub>i</sub> would compete with B<sub>i</sub> + O<sub>i</sub> → BiO<sub>i</sub> ⇒ Borons are protected!

# Use VGL to calculate c-factor

VGL: **g**ain **l**ayer depletion voltage  
 VFD: **f**ully **d**epletion voltage

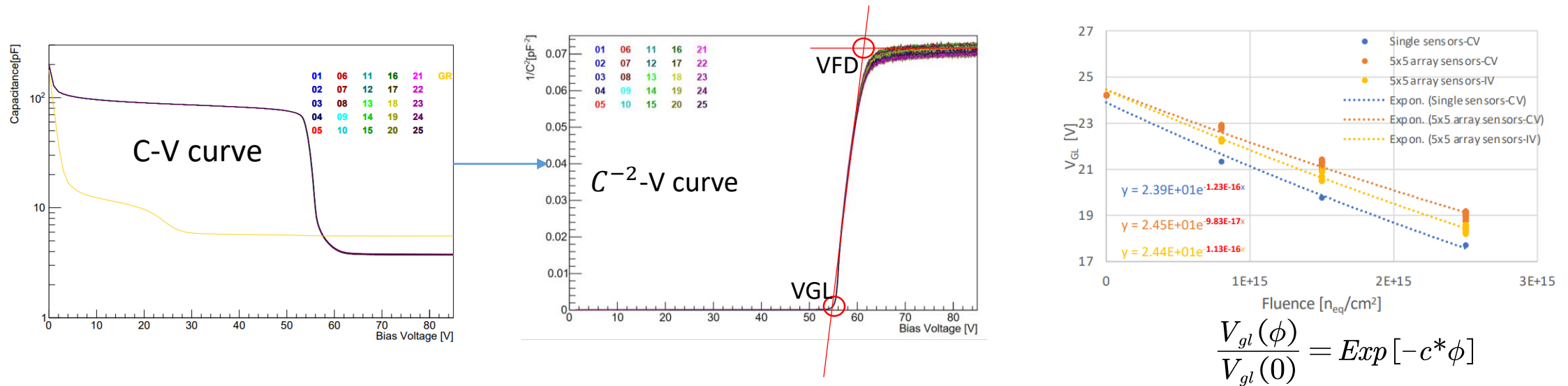

- Use extrapolating line segments to extract VGL and VFD from CV.
- Use the VGL at different fluences to fit the function and get the c-factor



# Evolution of the c-factor from different vendors

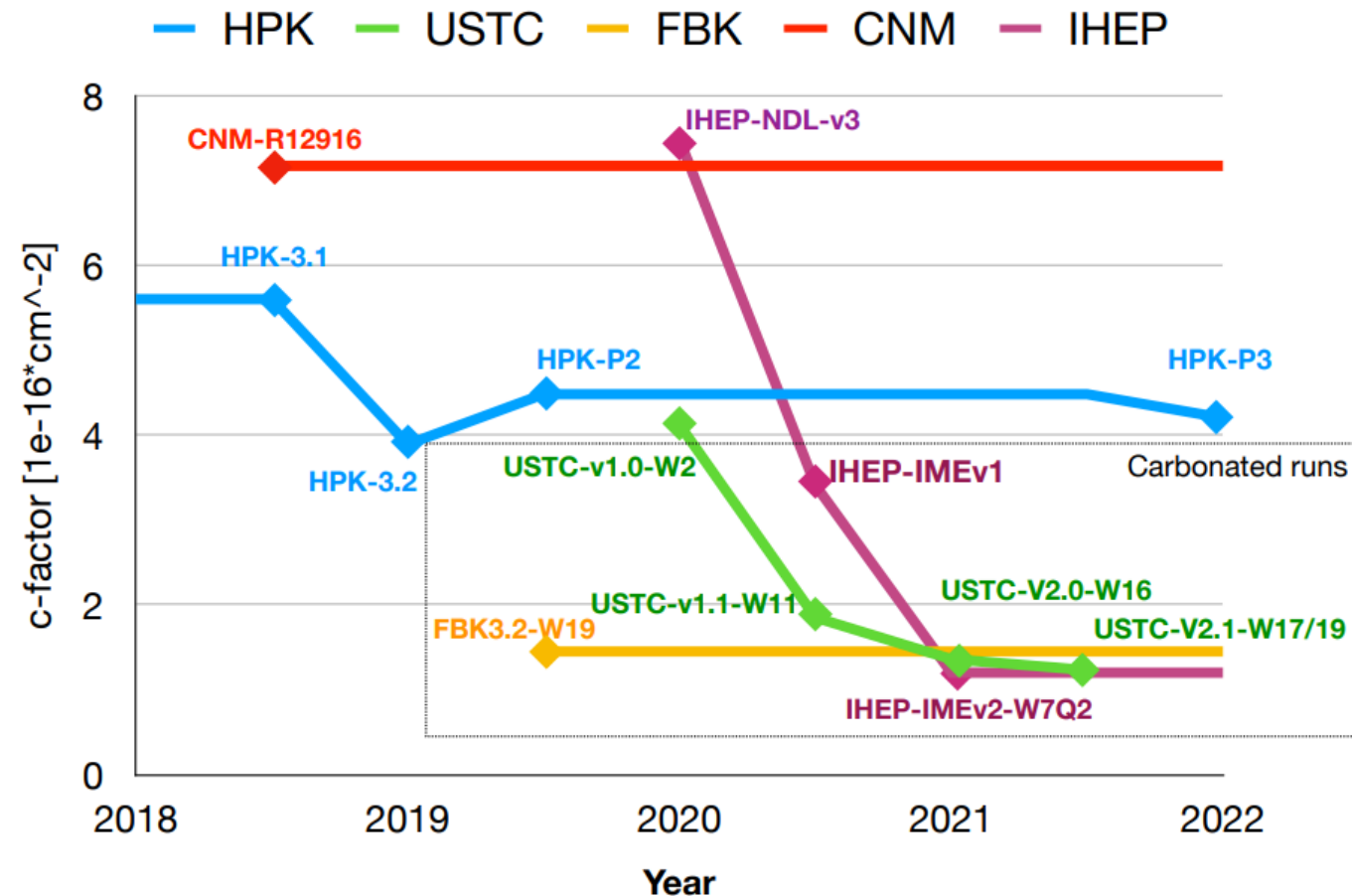

- c-factor measured with CV method on the most promising wafer (rad. hard) for each vendors' run.
- With the carbon in the gain layer, the USTC LGAD prototypes show promising radiation hardness compared to other vendors.

# On wafer I-V

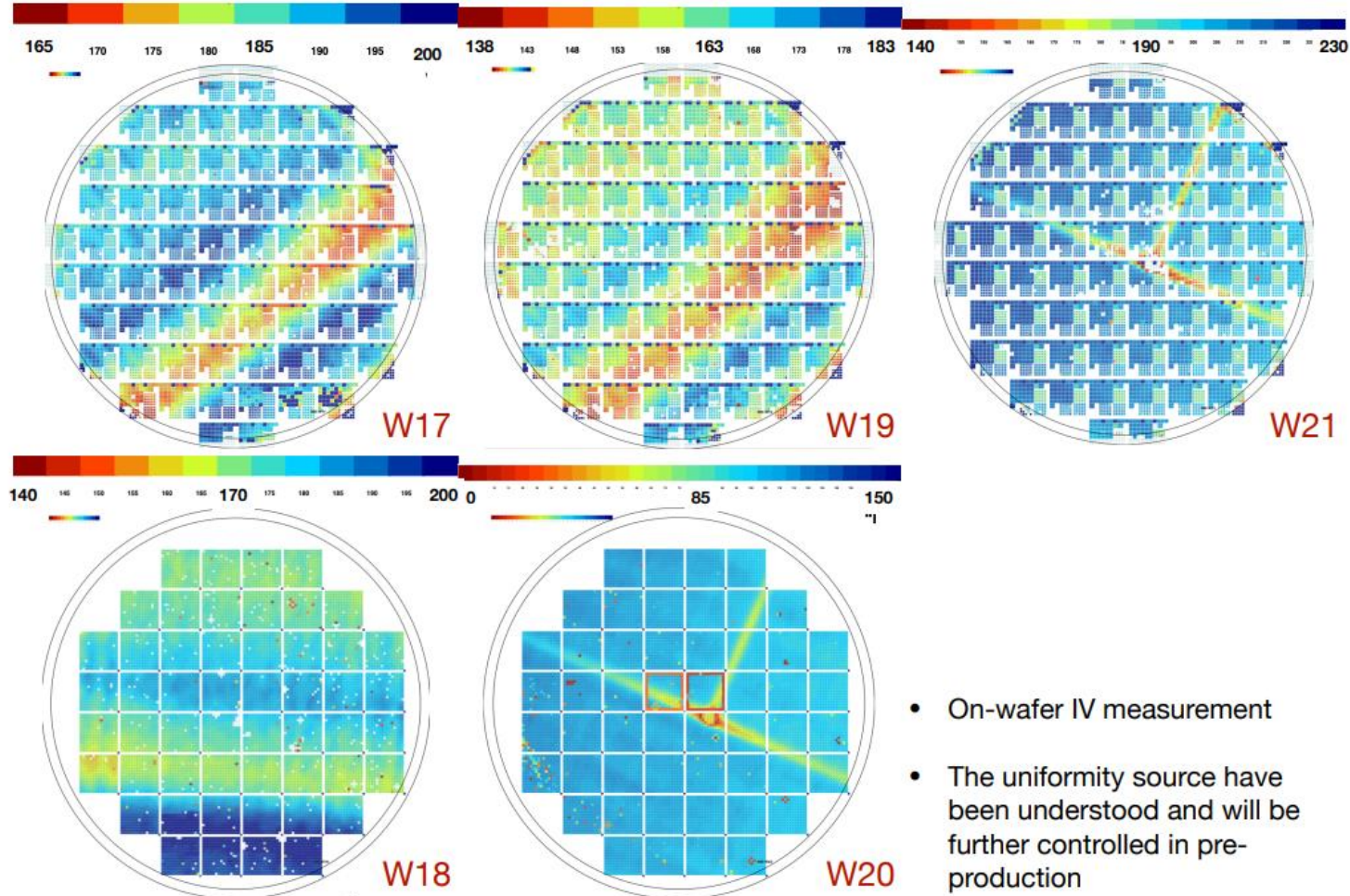

- Production of large array sensors is a big challenge for process technology.
- The VBD distribution is used to check the yield and uniformity.
- Before irradiated, most sensors' VBD are 150 ~ 240 V

- On-wafer IV measurement
- The uniformity source have been understood and will be further controlled in pre-production

VBD: **b**reak**d**own voltage

# IV&CV of irradiated 5x5 sensor

GR and all pads grounded  
T: 20 °C for CV, -30 °C for IV

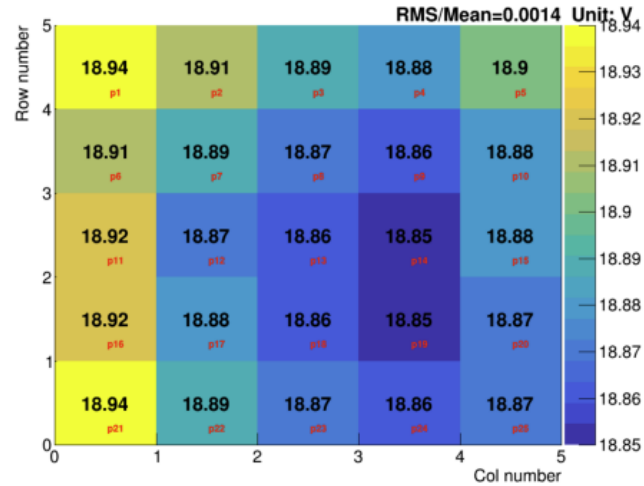
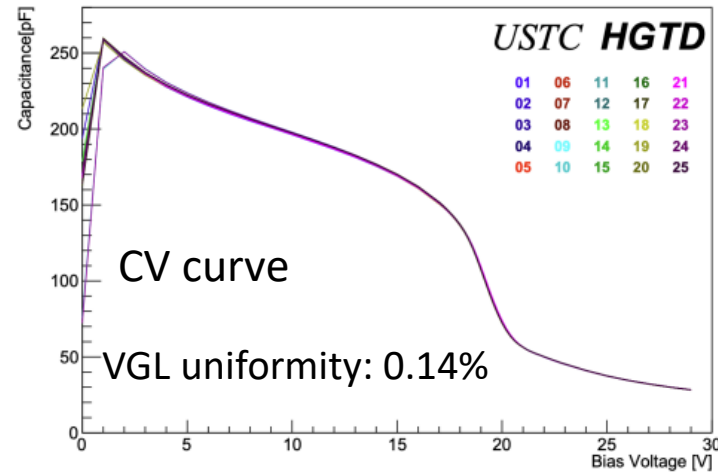

W17@2.5e15 n<sub>eq</sub> cm<sup>-2</sup>

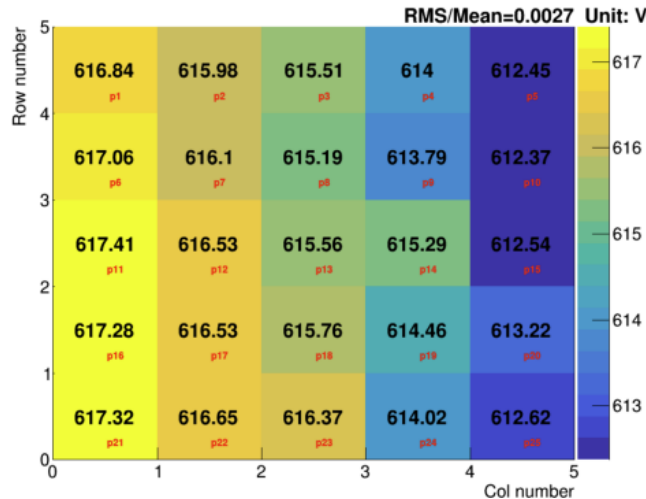
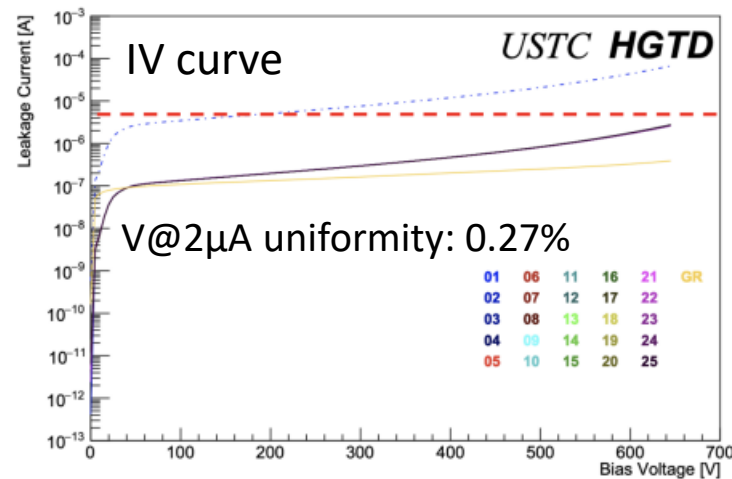

The uniformity of VGL and V@2μA is smaller than 1%, which meet the HGTD specification (5% for V@2μA)

# IV of irradiated 15x15 sensor

GR and all pads grounded  
T: -30 °C  
Step: 5.0 V

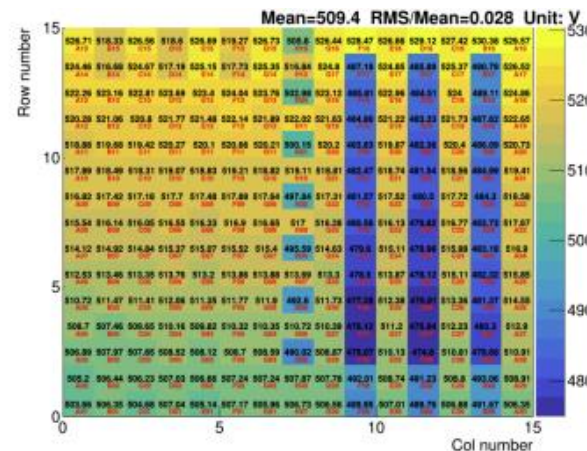
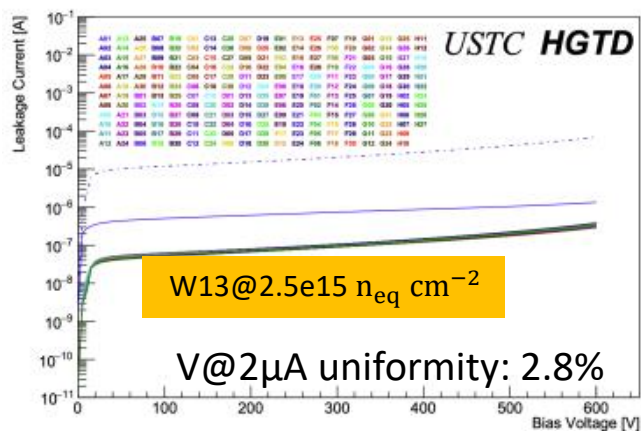

For the W13 and W15, the uniformity of V@2µA are both smaller than 5%.

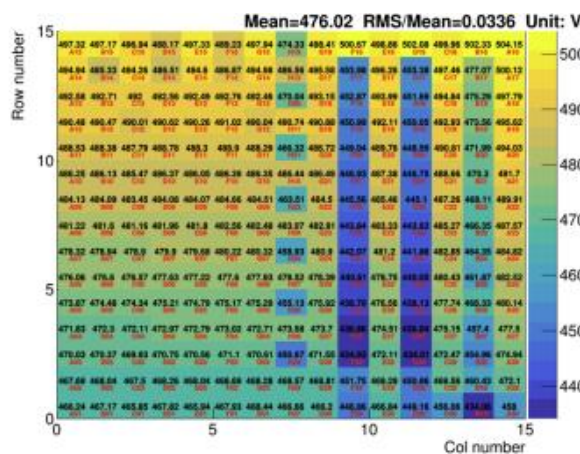
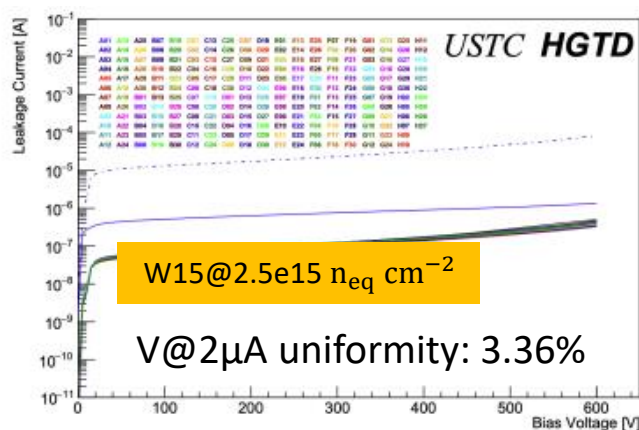

# Collected charge and time resolution from Beta-scope result

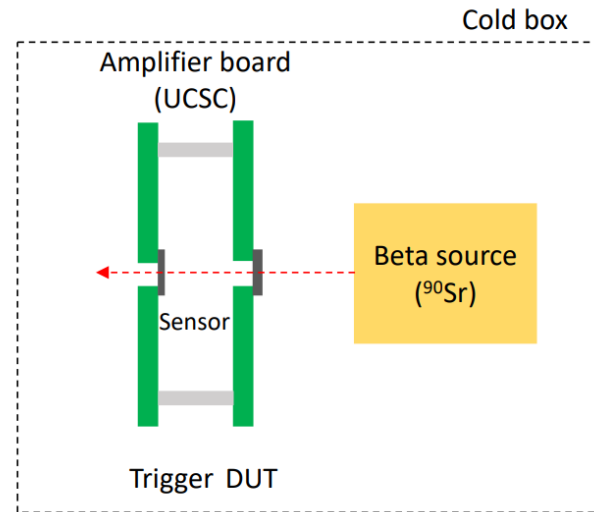
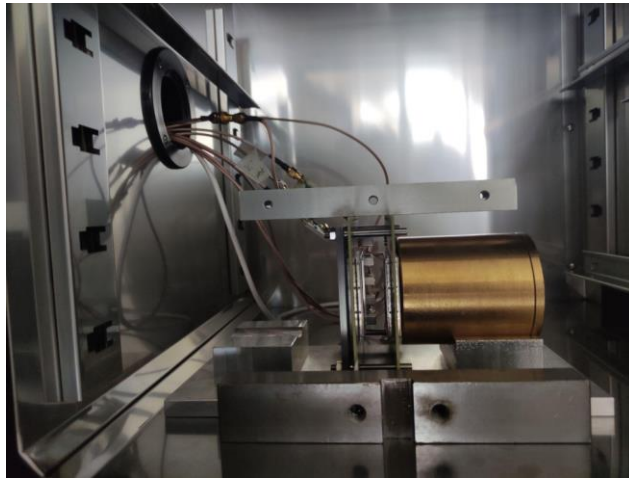

- The  $\beta$ -scope test for W17/W19 have been carried out at USTC and JSI.
- The results show the W17/W19 LGADs'  $\sigma_t$  can reach 50 ps and collected charge can  $> 4$ fC with bias voltage below 500 V after  $2.5E15$  fluences.
- The result have fulfilled the radiation hardness requirement of HGTD.

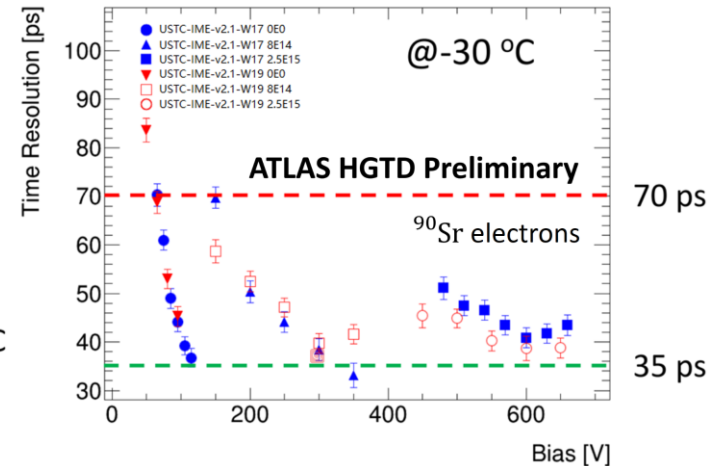
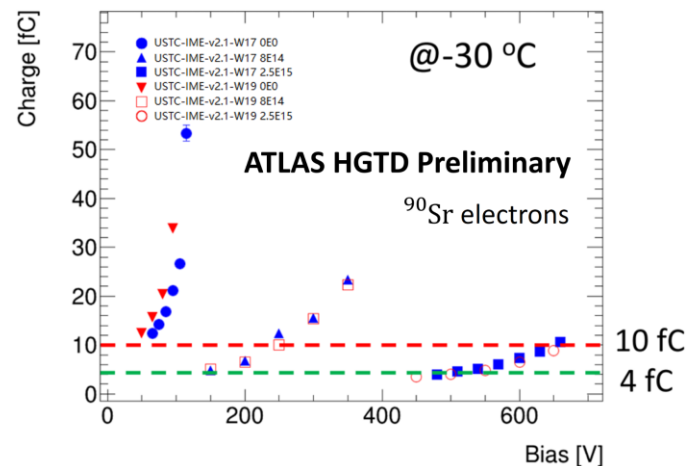

# Inter-pad gap measured by testbeam

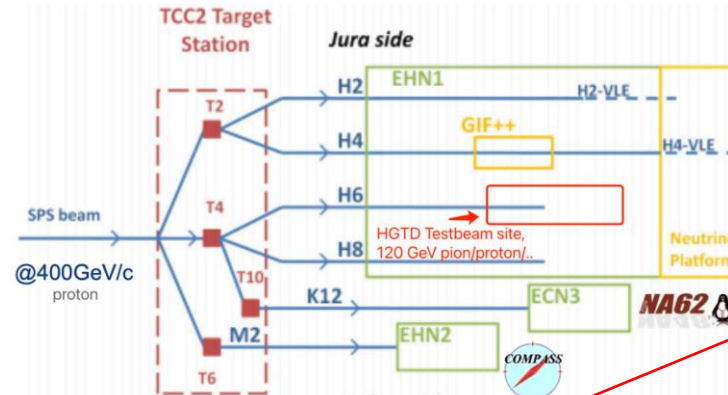
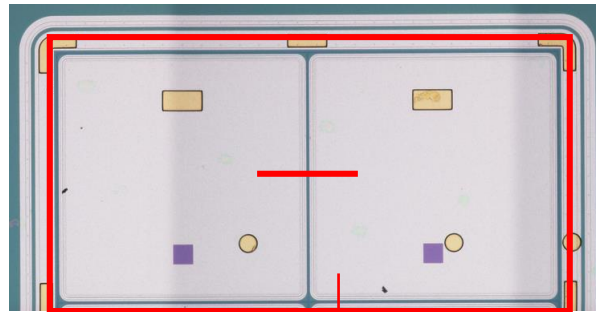

$$\text{Efficiency} = \frac{N(\text{tracks with charge} > 4fC)}{N(\text{all tracks})}$$

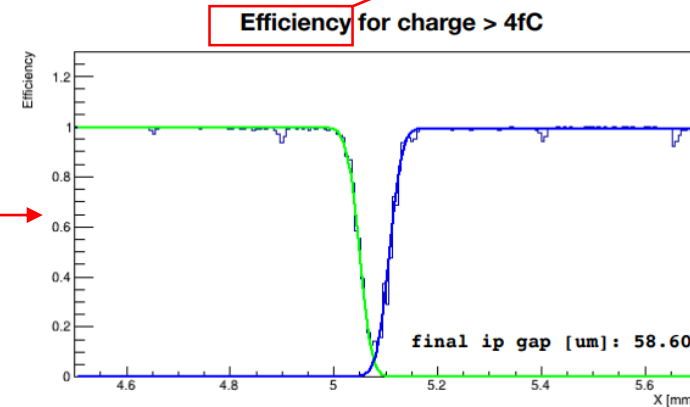
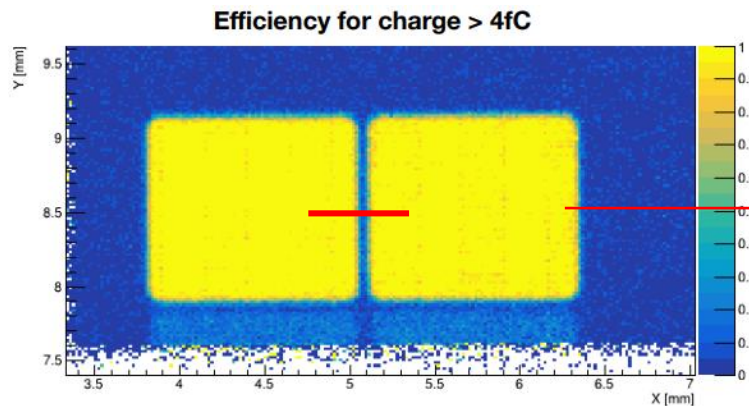

Sensor	Bias (V)	IP measured ( $\mu\text{m}$ )
W19 2x2 IP3	155	59
	145	63
	135	65
W17 2x2 IP3	170	60
	160	59
	150	62

- Use a continuous 120GeV pion beam to hit the sensor.
- The SPS testbeam show  $\sim 60 \mu\text{m}$  inter-pad gap for IP3 sensors.

Effective IP gap	70 $\mu\text{m}$	80 $\mu\text{m}$	90 $\mu\text{m}$	100 $\mu\text{m}$	110 $\mu\text{m}$	120 $\mu\text{m}$
Fill factor	90 %	88 %	87 %	85 %	84 %	82 %

# Inter-pad resistance

The inter-pad resistance and capacitance is a in-direct measurement of the cross-talk influence.  
(Quality of the pad isolation)

01	02	03	04	05
06	07	08	09	10
11	12	13	14	15
16	17	18	19	20
21	22	23	24	25

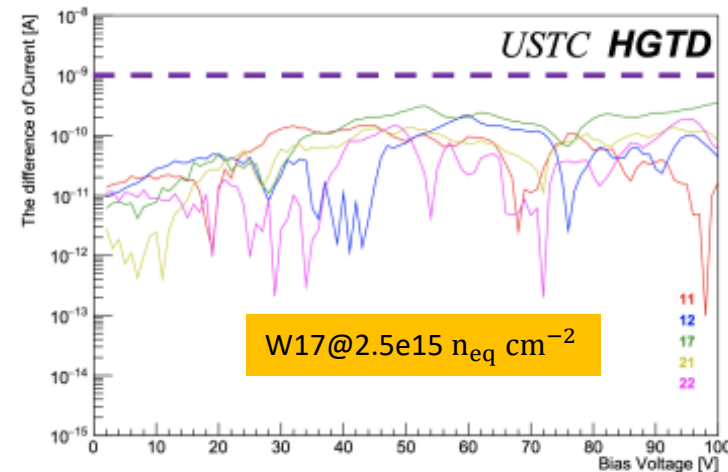

1 nA

GR and all pads grounded  
T: -30 °C  
Step: 5.0 V

- Apply negative high voltage to sensor's backside.
- Apply 0 or 1 V to center pad, GR and other pads grounded.
- Measure the current of other pads and get the current difference.
- The current between two pads is lower than 1 nA which means that the resistance is larger than 1 G $\Omega$ . This means the sensors meet the HGTD requirement.

# Inter-pad capacitance

01	02	03	04	05
06	07	08	09	10
11	12	13	14	15
16	17	18	19	20
21	22	23	24	25

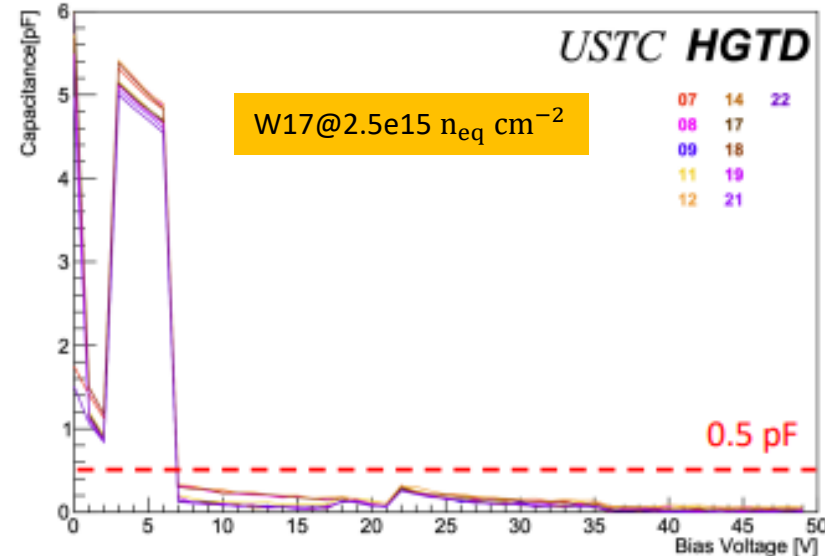

Frequency: 1 kHz

VAC: 0.51 V

GR and all pads grounded

T: 10 °C

Step: 1.0 V

- Apply negative high voltage to sensor's backside.
- Measured the inter-pad capacitance between the center pad and the other pads.
- After irradiated, the inter-pad capacitance can be smaller than 0.5 pF at appropriate bias voltage.
- The test result of the inter-pad resistance and capacitance have showed the cross-talk won't affect the sensor's performance.



# Conclusion

- LGAD: a novel detector with good time resolution and high radiation hardness.
- The USTC-IME V2.1 LGAD are well characterized in different test:

Characteristics	Performance
Radiation hardness	c-factor of W17 can reach $1.23 \times 10^{-16} \text{ cm}^2$
Breakdown voltage	150 ~ 240 V @pre-irrad.
Large array uniformity	For 5x5, uniformity of VGL and $V@2\mu\text{A} < 5\%$ @2.5e15. For 15x15, uniformity of $V@2\mu\text{A} < 5\%$ @2.5e15
Inter-pad gap	~60 $\mu\text{m}$ gap @IP3 achieved
Time resolution	35 ps @pre-irrad. , 50 ps @2.5e15
Collected charge	> 50 fC @pre-irrad. , > 4 fC @2.5e15
Inter-pad resistance	> 1 G $\Omega$ @2.5E15
Inter-pad capacitance	< 0.5 pF @2.5e15

- All parameters indicate they meet the HGTD specification.
- The pre-production (USTC-IME-V3.0) is on-going with all changes adapted to the latest HGTD requirement.

# Relative Paper

- [Radiation hardness characterization of low gain avalanche detector prototypes for the high granularity timing detector](#)
- [Performance of LGAD sensors with carbon enriched gain layer produced by USTC](#)
- [Performance in beam tests of Carbon-enriched irradiated Low Gain Avalanche Detectors for the ATLAS High Granularity Timing Detector](#)

backup

# CV&IV before&after irradiated

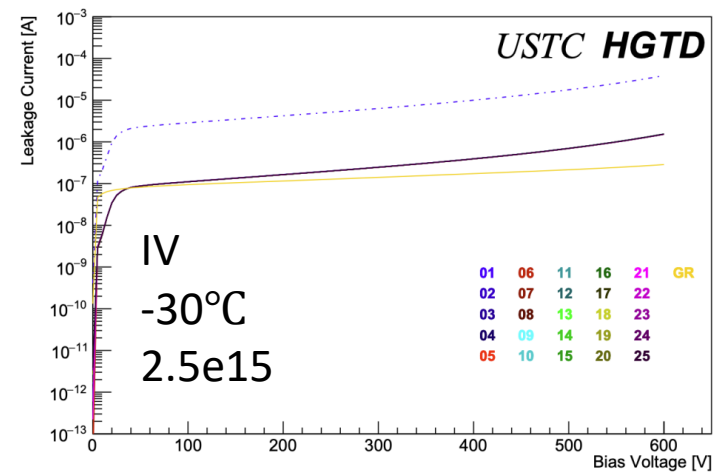
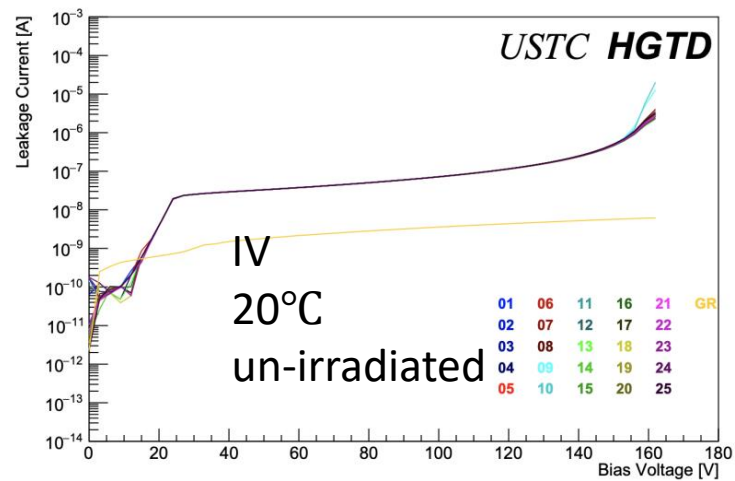
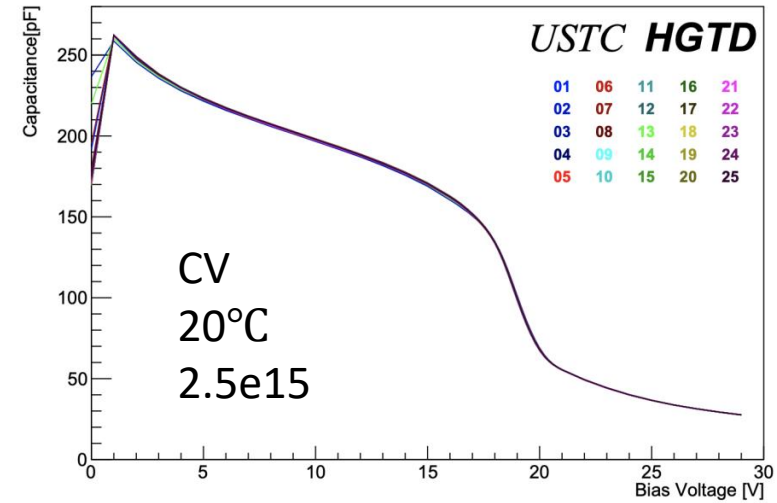
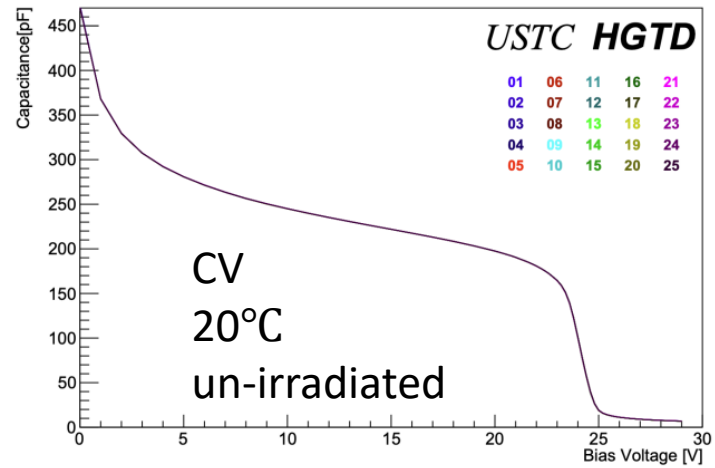

# IV & CV setup

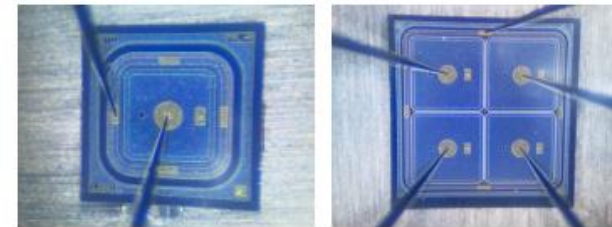
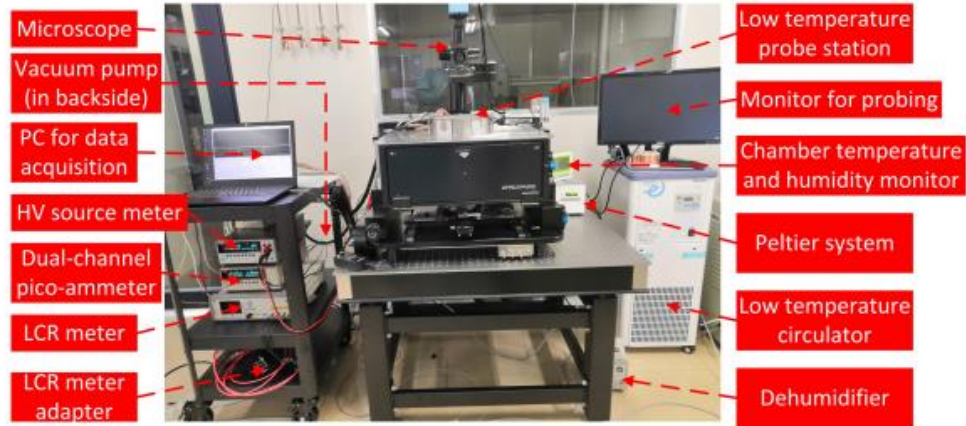

Tested by probe needles

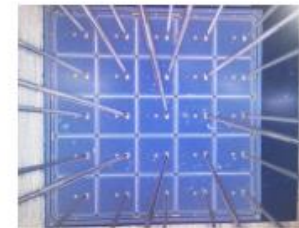

Tested by probe card

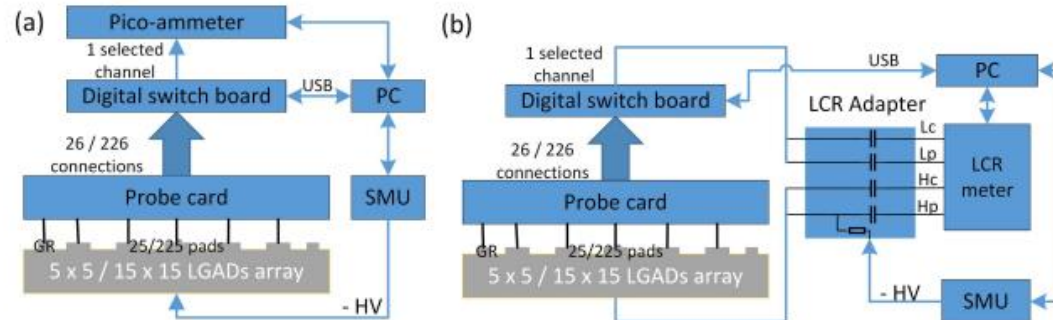
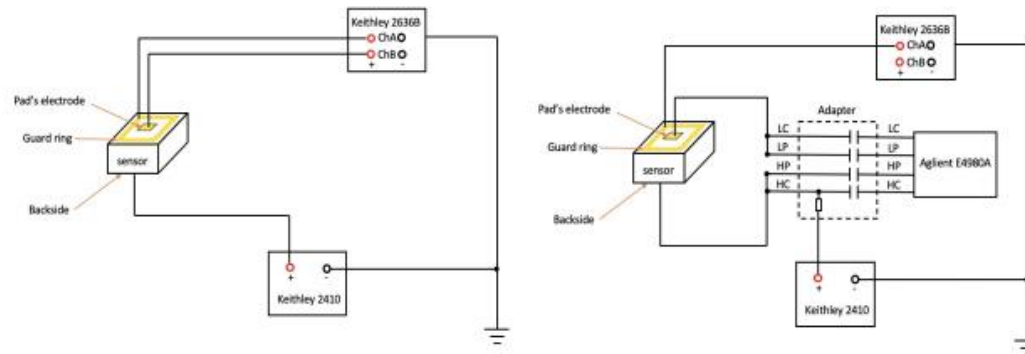

[J.J. Ge, NIMA, 2021](#)

# $\beta$ - scope setup

[C.H.Li, NIMA, 2022](#)

- Temperature: -30 °C
- Trigger
  - Sensor (HPK Type1.1, un-irradiated) & Pre-amplifier board
  - With the 2<sup>nd</sup> stage amplifier
  - Bias: -165.00 V
  - $\sigma_t$ : 33.88 ps
- DUT (Device Under Test)
  - Sensor & Pre-amplifier board
  - With the 2<sup>nd</sup> stage amplifier
- Oscilloscope
  - Sampling rate: 20 Gs/s
  - Bandwidth: 1 GHz

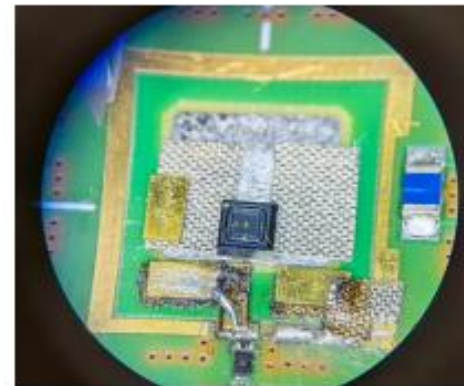
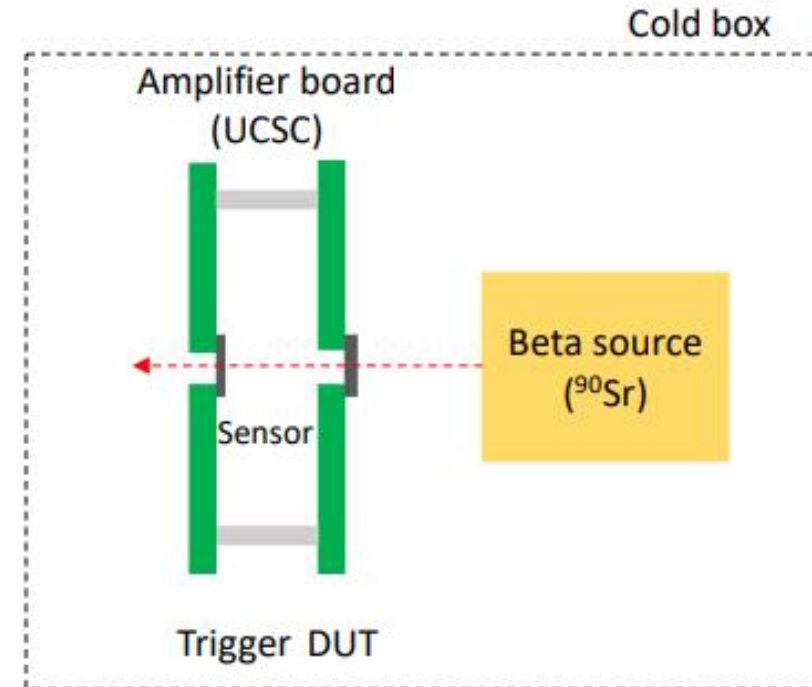

# Test-beam setup

